

Huntersville Public Art Commission

Summary Minutes: August 14, 2024



Members Present: Leonard King, Ryan Flores (Co-Chair), Ed Esinhart (Chair), Kendall Kendrick, Jessica Horton, Lynn Cavanaugh

Members Absent: Tim Kendra-Dill

Town Staff Present: Tracy Houk

Town Board Present: Commissioner Dumas

Public Present:

Call To Order: Ed Esinhart – 6:32 pm

Approval of Minutes: March 20, 2024 - Approved unanimously

Agenda Changes:

Public Comments, Requests, or Presentations:

- Hambright Park and Ride Artist, Anna Dean and CATS Art in Transit Program Administrator, Chris Lange
 - Project overview and Artist introduction
 - See the attached presentation

Business:

- Plein Air Event – Lynn
 - See attached *Huntersville Plein Aire Quick Draw Notes*
 - Will need to secure a sponsor for participant prizes.
 - Potential Plan: Have a PAC tent at Hello Huntersville with 1 to 2 Plein Aire artists to help promote the event. Later that month host the actual Plein Aire competition along the Downtown Greenway. Possibly partner with 760 for the judging and awards for the artists.
 - Idea...Community vote on which piece(s) the Town would buy to display in Town Hall.
 - Partner with Arts for All Gallery
 - Hello Huntersville: May 4, 2025
 - Possible event date: May 31, 2025 or June 7, 2025
- Electricities Grant
 - \$5000 matching grant
 - Possible projects to apply for the grant: Plein Aire Event or Mural on HACC
- 2024 Goals
 - See attached
 - Electricities grant – applying
 - Pop-up markets – trying out this fall
 - Funding and Grants – Town approved \$10,000 for the SculpTOUR in FY25 budget

- Expand into other areas of town – talked about putting more art in our parks, this may be an Electricities Grant option as well.
 - Peace Poles – all installed
 - Sponsorship info on the website - staff is working on a new sponsorship packet for 2025
 - Work with North State Development on adding new artwork – Staff will reach out
 - Tap into Culture Blocks through ASC for more programming: Staff met with ASC staff to look at Huntersville facilities this past spring. Hopefully, more artists/groups will be more aware of our facilities for programming space.
- Review SculptOUR RFP for Fall 2025-2027
 - No changes need to be made at the moment. Please review the RFP and we will discuss at the next meeting.

Updates/Comments:

- The September Meeting is Cancelled
 - *Motion made by Lynn to cancel the September meeting, there are not any time-pressing action items and Tracy will be out of town at a conference. Second, Jessica – All approved.*
- NC 250 Grant – we did not receive it. There is another round, Kendall will check with the committee on if we can apply again for the same project.

Motion to Adjourn: 7:49 pm – Motion to adjourn.

Anna G. Dean

Artist, Hambright Park and
Ride



Previous Projects...

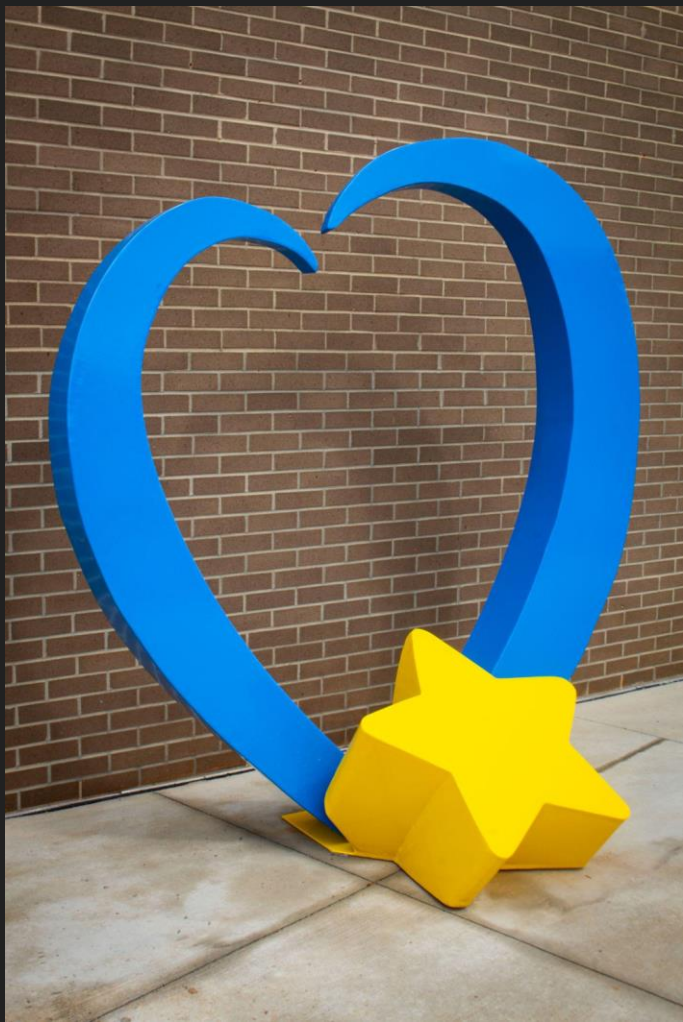

MIRACLE PARK

ROCK HILL, SC



Miracle Park
Ten Thousand and 00/100
\$ 10000
for the kids



Thank You To Our Donors



Rock Hill
Parks
Foundation

City of
Rock Hill

MaxAbilities
of York
County

Dick & Jan
McCoy

BAR
Contractors
LLC

Founders
Federal
Credit Union

Panther
Heating
and Air

Carolina
Panthers
Charities

Good Parks
of York
County

Sammy
Dobson



The McColl Center / Atrium Health

... an investigation into Covid-19







Cloud Migration

For Link Apartments, Noda

... formerly Herrin Brothers Coal and Ice

Tora Sushi





Winston



Elan Loso

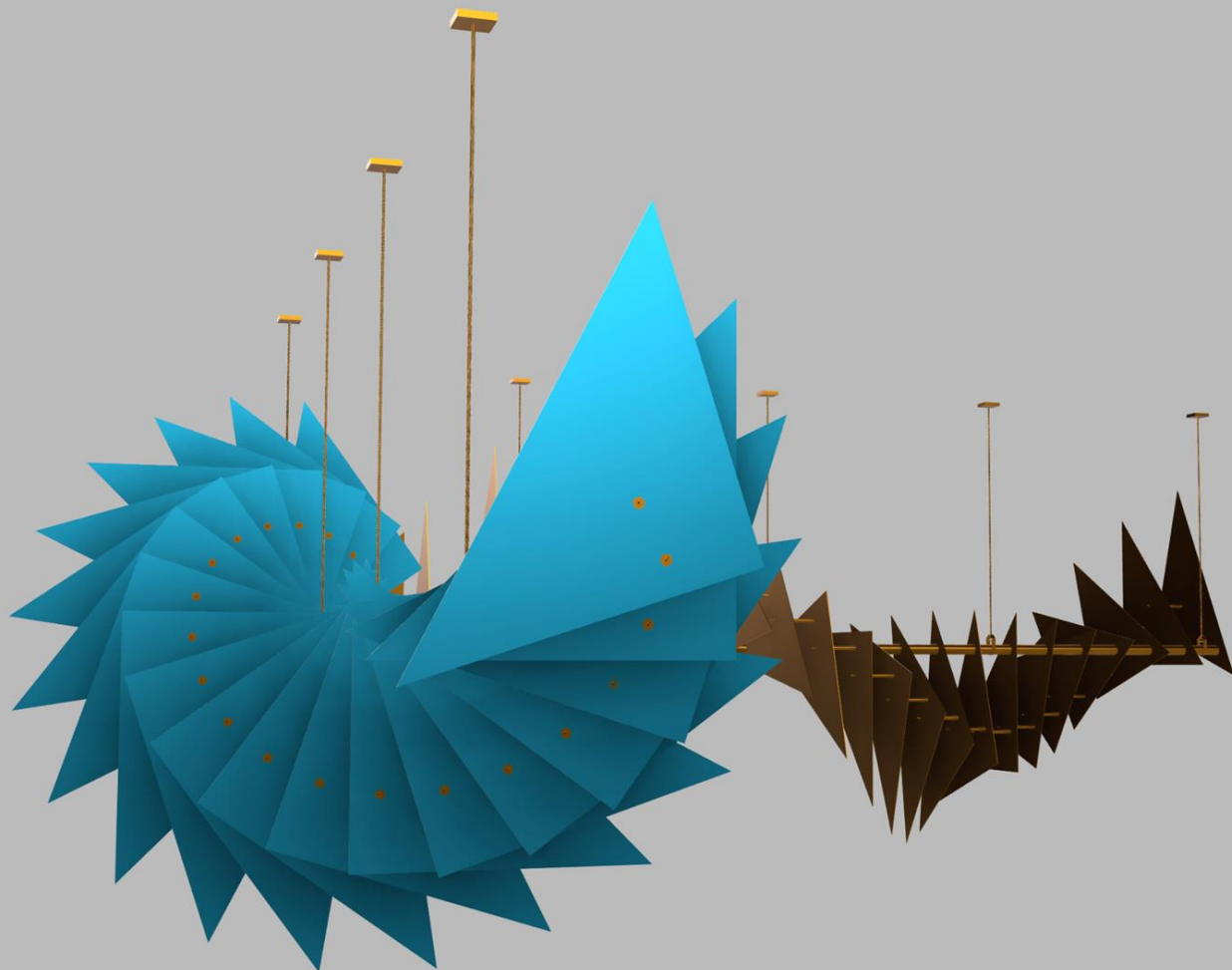

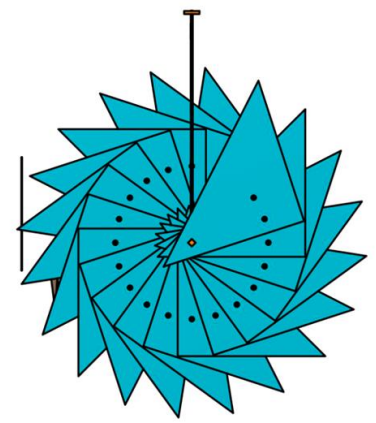
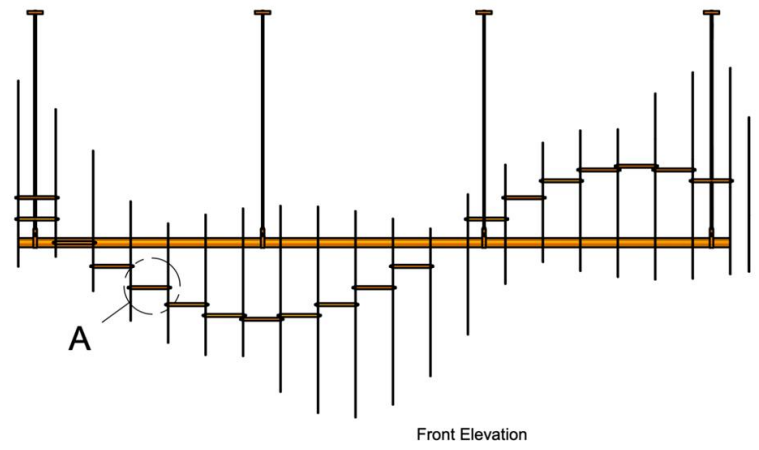
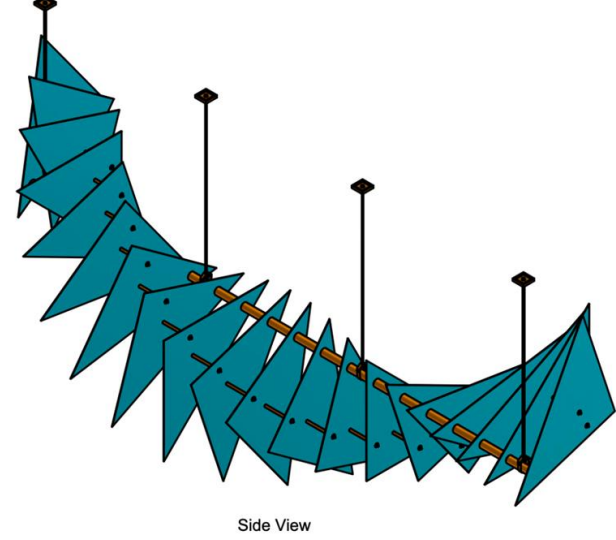
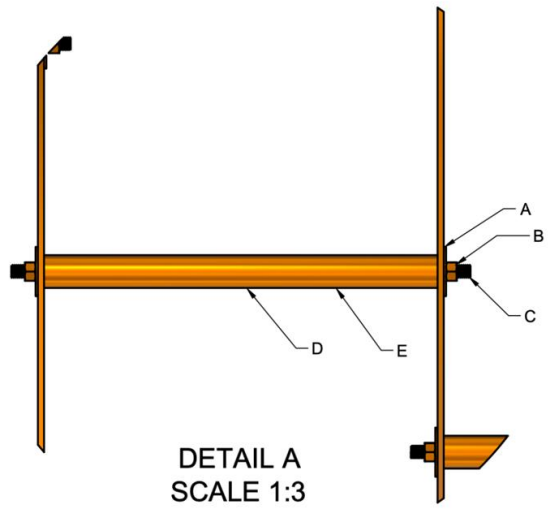

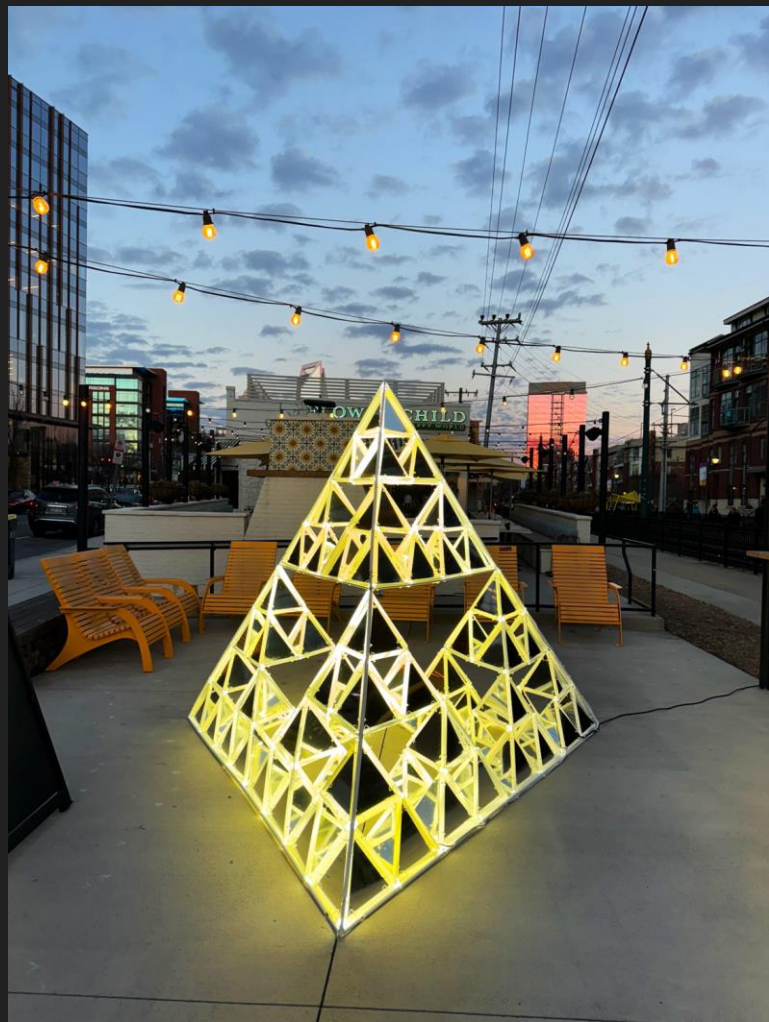
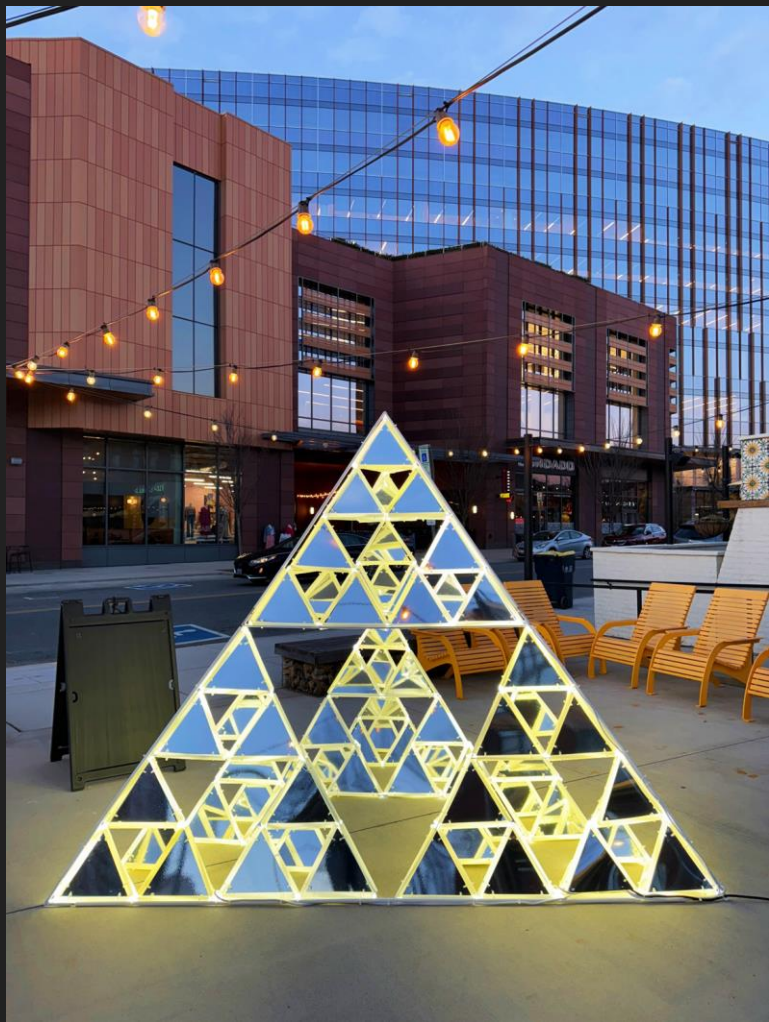

My work...

Activates public space

Invites people into interesting conversations

Plays with layers, light and shadow

Incorporates big ideas / asks big questions

... and also looks cool.

I need your feedback!

What do you want to see?

What are the needs of your community?

What makes this place special / unique?

How can we make this space better?



**30% PRELIMINARY ENGINEERING
FOR REVIEW ONLY**
NOT TO BE USED FOR CONSTRUCTION
SUBJECT TO CHANGE WITHOUT NOTICE

GENERAL NOTES ARCHITECTURAL SCOPE OF WORK:

1. THE ARCHITECTURAL PLANS INCLUDE TWO SEPARATE SITE LAYOUT, COMFORT SHELTER AND BUS SHELTER CONCEPTS, INTENDED TO SOLICIT CLIENT FEEDBACK ON PREFERABLE PLANS, RELATIONSHIP'S AND MATERIALS.
2. AFTER THE ON PHASE, THE TWO CONCEPTS WILL BE REFINED INTO FINAL CONCEPT BASED ON CLIENT FEEDBACK.
3. CONCEPT 1 AND CONCEPT 2 ARE NOT MUTUALLY EXCLUSIVE, PORTIONS OF EACH CONCEPT CAN BE INCLUDED INTO THE FINAL DESIGN SOLUTION IF DESIRED BY THE CLIENT.

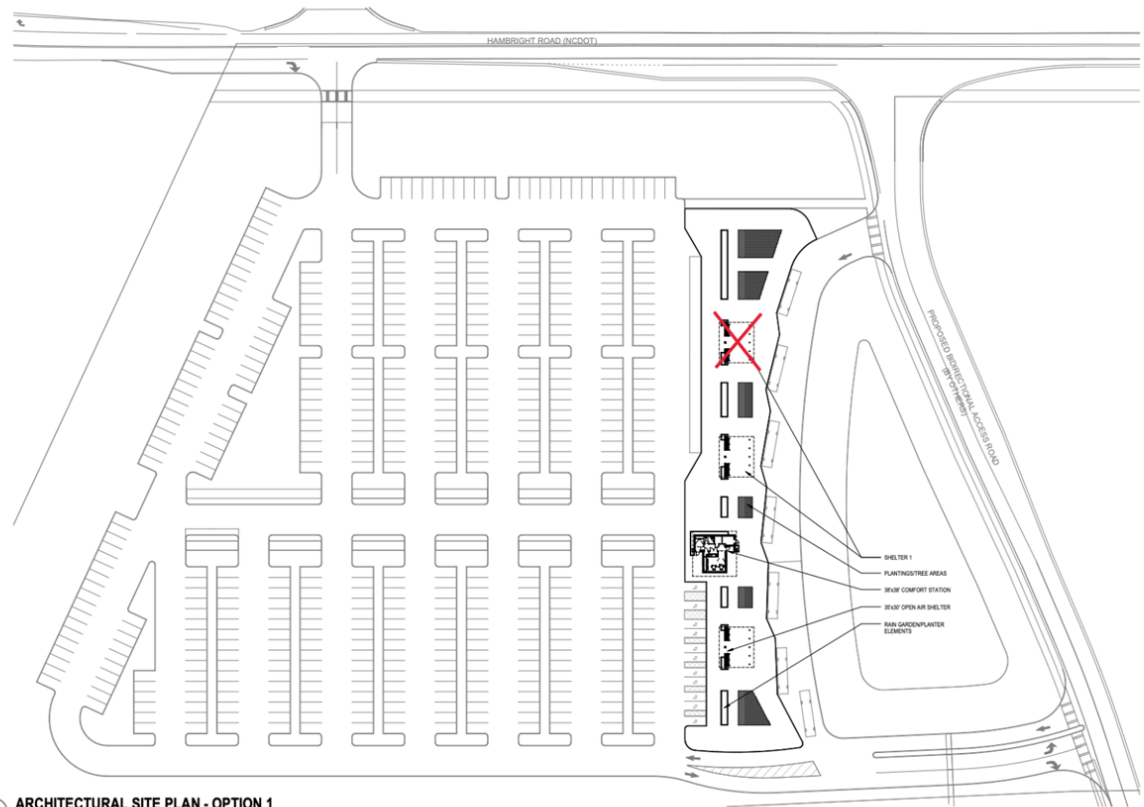

1 ARCHITECTURAL SITE PLAN - OPTION 1
AS06 SCALE: 1" = 80'-0" R.E. = 1

NO.	DATE	REVISION	BY	CHK	APP

neighboring
COMMUNITIES • PARTNERS • BUSINESS

101 West Trade Street, Suite 10
Charlotte, North Carolina 28202
704.376.1000
www.neighboring.com

AMT
A. MURPHY THOMAS AND ASSOCIATES, INC.
1000 SOUTH TRYON AVENUE, SUITE 1000
CHARLOTTE, NC 28203
704.376.1000
WWW.AMTENGINEERING.COM

CATS
CHARLOTTE AREA TRANSIT SYSTEM

DESIGNED BY:	ELF
DRAWN BY:	ELF
CHECKED BY:	LAV
APPROVED BY:	-

HAMBRIGHT PARK AND RIDE

CONCEPT OPTION 1
ARCHITECTURAL SITE PLAN

DATE:	06/28/24
SHEET:	HBR-020
OWNER:	HBR-S-ARC-SLO-001
CONTRACT NO.:	1

**30% PRELIMINARY ENGINEERING
FOR REVIEW ONLY**
NOT TO BE USED FOR CONSTRUCTION
SUBJECT TO CHANGE WITHOUT NOTICE



1 EAST ELEVATION - COMFORT STATION OPTION 1
A201 SCALE: 1/4" = 1'-0"

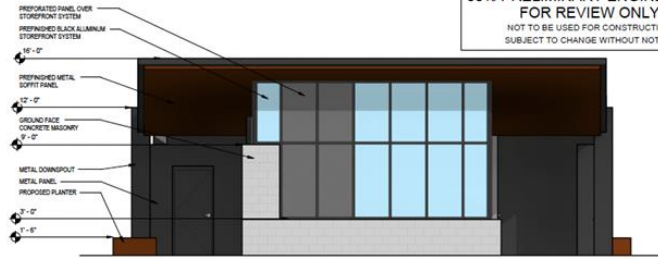

2 SOUTH ELEVATION - COMFORT STATION OPTION 1
A201 SCALE: 1/4" = 1'-0"

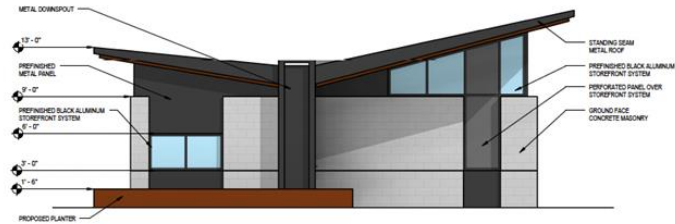

3 WEST ELEVATION - COMFORT STATION OPTION 1
A201 SCALE: 1/4" = 1'-0"



4 NORTH ELEVATION - COMFORT STATION OPTION 1
A201 SCALE: 1/4" = 1'-0"



5 3D View 1 - COMFORT STATION OPTION 1
A201 SCALE: REE = 1'



6 3D View 2 - COMFORT STATION OPTION 1
A201 SCALE: REE = 1'

NO.	DATE	REVISION	BY	CHK	APP



REVIEWED:	ELF
DRAWN:	ELF
DESIGNED:	LAV
PROJECTED:	-

HAMBRIGHT PARK AND RIDE

CONCEPT OPTION 1
COMFORT STATION
EXTERIOR ELEVATIONS

DATE:	06/28/24
DRAWN:	HBR-026
DESIGNED:	HBR-S-ARC-ELV-001
PROJECT NO.:	1

30% PRELIMINARY ENGINEERING
 FOR REVIEW ONLY
 NOT TO BE USED FOR CONSTRUCTION
 SUBJECT TO CHANGE WITHOUT NOTICE

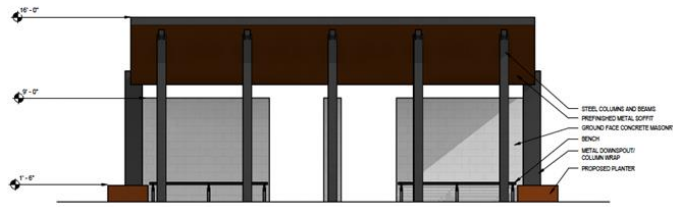

1 EAST ELEVATION - SHELTER 1
 A202 SCALE: 1/4" = 1'-0"

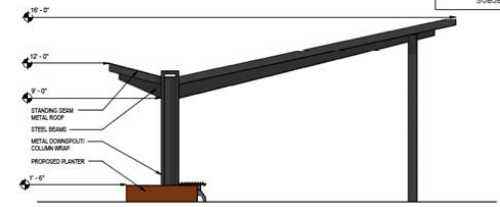

2 SOUTH ELEVATION - SHELTER 1
 A202 SCALE: 1/4" = 1'-0"

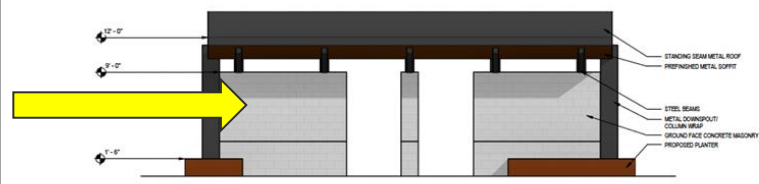

3 WEST ELEVATION - SHELTER 1
 A202 SCALE: 1/4" = 1'-0"

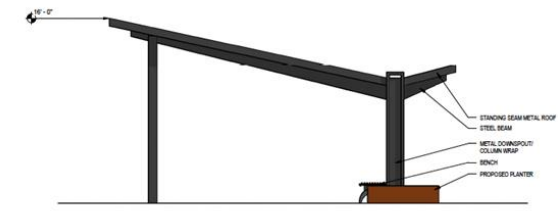

4 NORTH ELEVATION - SHELTER 1
 A202 SCALE: 1/4" = 1'-0"

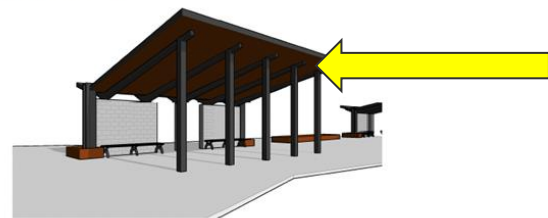

5 3D View 1 - SHELTER OPTION 1
 A202 SCALE:



6 3D View 2 - SHELTER OPTION 1
 A202 SCALE:

NO.	DATE	REVISION	BY	CHK.	APP.

neighboring
 CONCEPTS
 ARCHITECTURE • PLANNING • INTERIORS

AMT
 A MORTON THOMAS AND ASSOCIATES, INC.
 10101 WILSON ROAD, SUITE 100, CHARLOTTE, NC 28228
 TEL: 704.536.1100 FAX: 704.536.1101
 WWW.AMTENGINEERING.COM

GATS
 CHARLOTTE AREA TRANSIT SYSTEM

PREPARED BY:	ELF
DRAWN BY:	ELF
DESIGNED BY:	LAV
APPROVED BY:	-

HAMBRIGHT PARK AND RIDE

CONCEPT OPTION 1
 WAITING SHELTER
 EXTERIOR ELEVATIONS

DATE:	05/28/24
PROJECT:	HRB-027
PROJECT NUMBER:	HRB-S-ARC-ELV-002
CONTRACT NO.:	1

Huntersville Plein Aire Quick Draw Notes

- 4 hour event, starting at 8:00 am through noon
 - We will give artists an hour to finish and get their entry ready with pieces submitted at 1:00 with judging a
 - The award announcement would be in the afternoon coordinated with the event
 - This would be considered a Quick Draw event
- Artists bring paper or canvas to a central location to have the back stamped
 - Note that only stamped entries will be accepted
 - Artists may prepare paper/canvas but no pre-drawing or painting will be allowed
- Artists may use any medium but work must be completed in the 4 hour window
- Draw from 4 pre-defined locations within Huntersville. These will be advertised, encouraging people to go to the locations to view the painters
 - We will need a Public Art Council member at each location
 - I do not yet have recommendations for sites other than the Greenway
- We will require an entry fee - \$25 to \$30
- 1st Place prize - \$300, 2nd Place - \$200, 3rd Place - \$100 – we may need to get a grant to support the total prize pool of \$600 plus judge's fee
- We will need to find a judge and we will need to pay them \$100 to \$150
 - Robin Stockton will judge or help us find someone to do the judging
 - We will need 23-28 participants to cover the prizes and judges fee
- This will be considered a wet judging event with Artists required to provide framing the day of the event which will be used to hang in gallery
- All pictures submitted for judging must be available for sale
- All pictures submitted will be displayed in the Arts for All Gallery for a specific period of time (to be determined)
 - Robin Stockton has agreed to work with us on the event
 - She charges a commission of 30% on sales
 - We were thinking of a 30 day show but would need to coordinate dates
- Event will need to be advertised as well as appearing on the Huntersville website
 - I would like to see Facebook and Instagram blasts if possible
 - Robin will also advertise on her social media sites
- I recommend that we combine this with Hello Huntersville next May – we may be able to do a standalone event sometime in the future but will want to get established first